

VistaCool™

Installation Guide & Owner's Manual

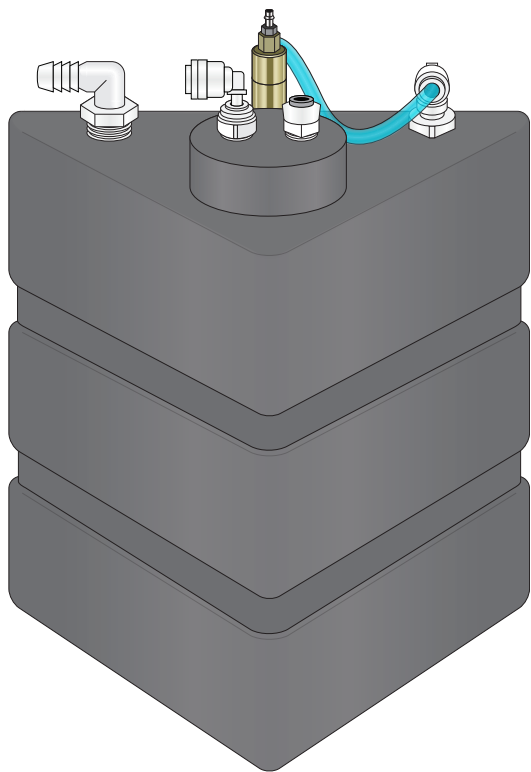

Model 7501

For **1**
Autoclave

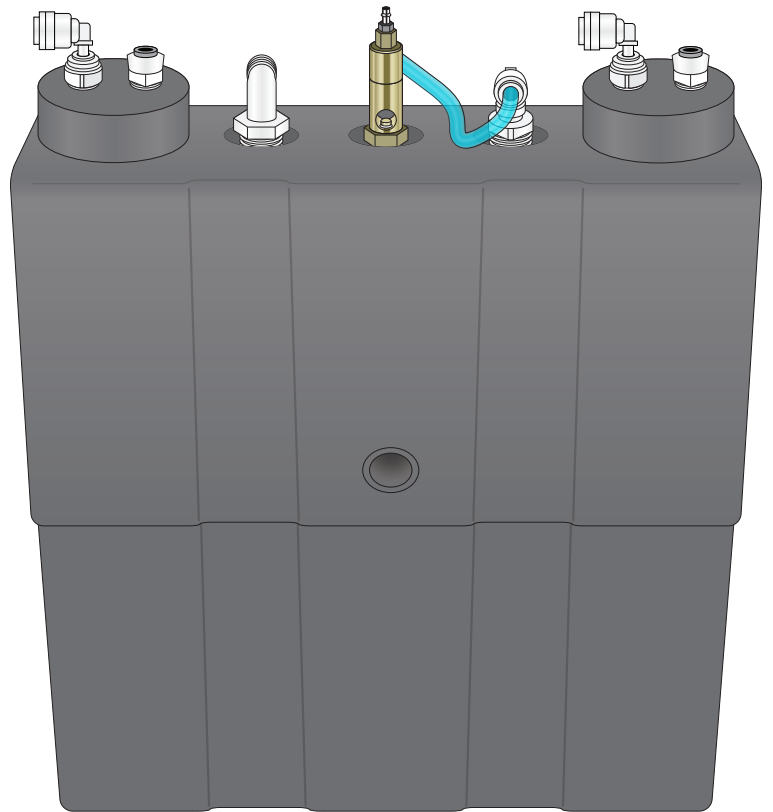

Model 7502

For **2**
Autoclaves

VistaCool™

Direct-to-Drain Thermal Reduction
System for Autoclave Wastewater



Includes CSA-Certified
VistaCheck Dual Check
Backflow Preventer

VistaCool can be used with:

Midmark/Ritter M3 SciCan STAT/M 2000
Midmark/Ritter M9* SciCan STAT/M 5000
Midmark/Ritter M11*

* Requires Model 7502 and S7560 adapter kit

Table of Contents

Introduction	3
Important Information	3
Preparation - 7501	4
Preparation - 7502	5
Typical Installation - 7501	6
Typical Installation - 7502	7
Plumbing	8
Cabinetry	9
Connecting the System	10
Tank Positioning	12
Starting & Using the System	12
Autoclave-Specific Instructions	13
Maintenance	14
Troubleshooting	14
VistaCool Limited Warranty	15
VistaCool System Information & Specifications	16

Distribution

VistaCool systems are sold through dental and medical dealers throughout North America by:

Midmark Corporation

Midmark.com

60 Vista Drive
Versailles, Ohio 45380
United States of America

PHONE (937) 526-3662
FAX (800) 365-8631
TOLL FREE (800) 643-6275

SciCan Inc.

SciCan.com

701 Technology Drive
Canonsburg, Pennsylvania 15317
United States of America

PHONE (724) 820-1600
FAX (724) 820-1479
TOLL FREE (800) 572-1211

SciCan Ltd.

SciCan.com

1440 Don Mills Road
Toronto, Ontario M3B 3P9
Canada

PHONE (416) 445-1600
FAX (416) 445-2727
TOLL FREE (800) 870-7777

Vista Research Group

 VistaResearchGroup.com  vrg.support  (419) 281-3927
 1733 West Parkside Lane, Phoenix, AZ 85027

VistaCool is patent pending.

VistaCool is a trademark of Vista Research Group, LLC.
M3, M9 and M11 are trademarks/models of Midmark Corporation.
STATIM 2000 and STATIM 5000 are trademarks/models of SciCan Ltd.



Includes CSA-Certified
VistaCheck Dual Check
Backflow Preventer

Introduction

VistaCool is a patent-pending system designed to eliminate the need for autoclave condenser/waste bottles and condensation tanks by cooling the exhaust water and automatically sending it directly down the drain. With the use of a simple adapter kit, the VistaCool Model 7502 is designed to enable the Midmark/Ritter M9 and M11 autoclaves to use fresh deionized/distilled water for each sterilizing cycle—converting these chambered autoclaves to operate like quick-turnaround, cassette systems.

VistaCool can be used with:

Midmark/Ritter M3
Midmark/Ritter M9*
Midmark/Ritter M11*
SciCan STAT/M 2000
SciCan STAT/M 5000

* Requires Model 7502 and S7560 adapter kit

IMPORTANT INFORMATION

For System Owners



We recommend that a professional technician or plumber familiar with dental/medical offices perform the installation since interface with a cold water line and drain is involved. He/she should be familiar with local plumbing codes and techniques for successful dental/medical equipment installations. Failure to install correctly could result in water leaks, leading to possible water damage. It is the responsibility of the system owner to validate the use of all equipment within its installed environment.

Please keep the Installation Guide & Owner's Manual handy for future reference and ensure that anyone responsible for operation and maintenance of the system is familiar with all details contained in this manual.

Please return the Warranty Registration form or register online immediately upon installation.



IMPORTANT INFORMATION

For System Installers



Please read this entire manual before proceeding with installation and operation, and always follow local plumbing codes.

VistaCool systems have only been verified for installation on the compatible autoclaves (listed above). Please check with the manufacturer of other brands of autoclaves or contact Vista Research Group before connecting to other than SciCan or Midmark/Ritter autoclaves. See page 13 for autoclave-specific instructions.

-  VistaCool Model 7502 has been verified for installation on Midmark/Ritter M9 & M11 units with the use of the S7560 adapter kit. Only M9, M9D, M11 and M11D (-02X, -03X) units with **green** displays can be connected to VistaCool. First generation models with **red** displays (-0XX) are not compatible.
-  The VistaCool tank must be installed so that the top of the water tank is ABOVE the connection to the drain adapter. Please see page 12 for important tank positioning details.
-  Check for leaks and run the autoclave(s) for at least two consecutive cycles after installation to ensure the system is operating properly.

Preparation / 7501

For **1**
Autoclave

Remove all contents from the VistaCool product carton to make certain all items needed for installation are present and undamaged.

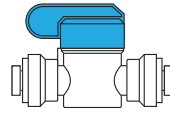
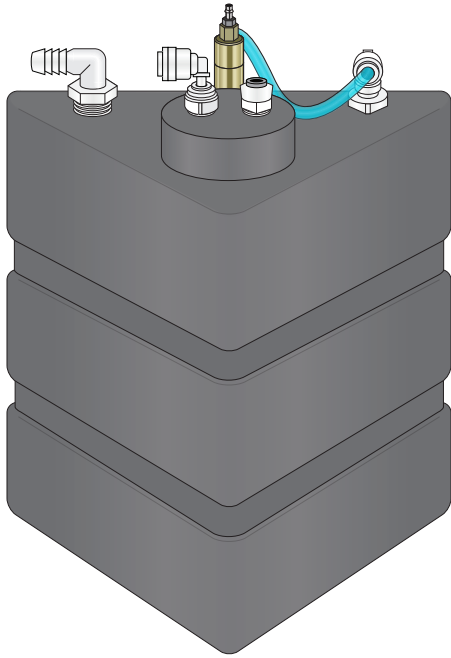

S6155
Water Supply Valve



S7570
M3 Mono Plug

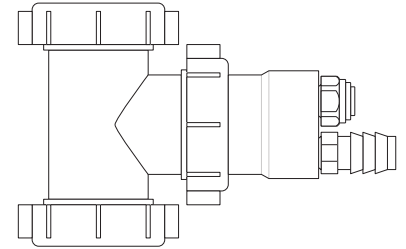

S7506
Drain Line Assembly



S7508
Inline Thermal
Sensor Assembly



VC250-A
VistaCheck Dual Check
Backflow Preventer



x4 S7539
Cabinet Grommet

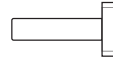

S6130
Plug

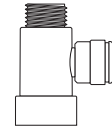

S6135
Angle Stop Adapter

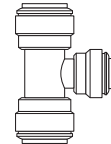

S6119
3/8" x 3/8" x 1/4" Tee Union

Tubing

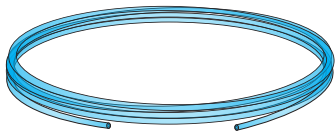

6' **TU751**
Cold Water Feed Line
1/4" OD x 1/8" ID
Blue Transparent Polyurethane



6' **TU753**
Condensate Drain Line
1/4" OD x 0.170" ID
Black Opaque LLDPE

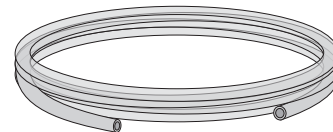

6' **TU755**
Coolant Overflow Drain Line
3/4" OD x 1/2" ID
Clear PVC

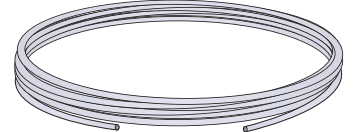

9' **TU748**
High Temperature Feed Line
1/4" OD x 0.185" ID
Teflon®

Remove all contents from the VistaCool product carton to make certain all items needed for installation are present and undamaged.

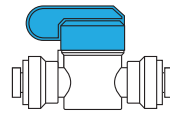
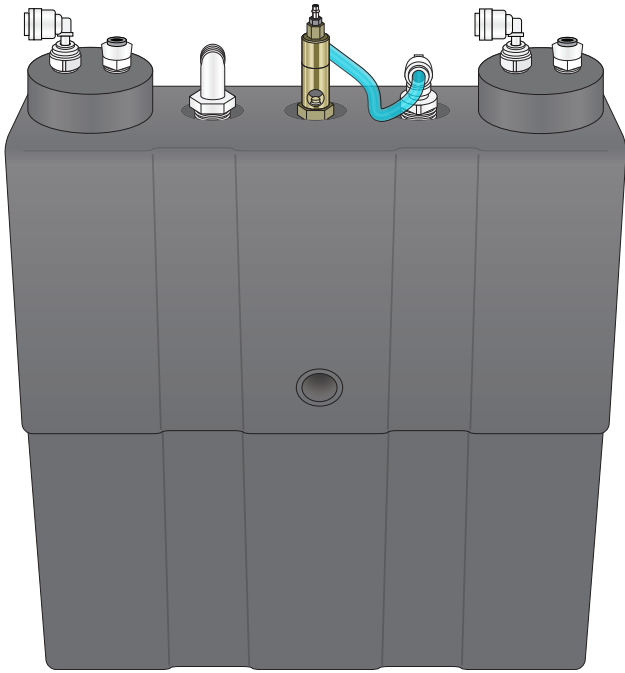

S6155
Water Supply Valve

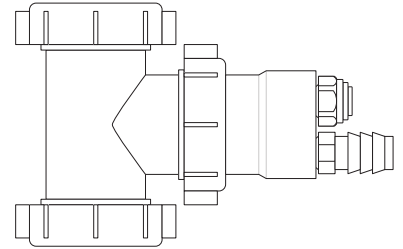

S7506
Drain Line Assembly



x2 **S7570**
M3 Mono Plug



x2 **S7508**
Inline Thermal
Sensor Assembly



VC250-A
VistaCheck Dual Check
Backflow Preventer



x8 **S7539**
Cabinet Grommet

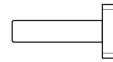

S6130
Plug

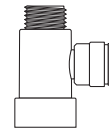

S6135
Angle Stop Adapter

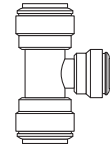

S6119
3/8" x 3/8" x 1/4" Tee Union

Tubing

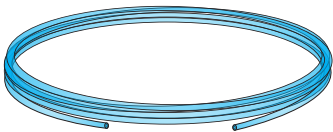

6' **TU751**
Cold Water Feed Line
1/4" OD x 1/8" ID
Blue Transparent Polyurethane



6' **TU753**
Condensate Drain Line
1/4" OD x 0.170" ID
x2 Black Opaque LLDPE

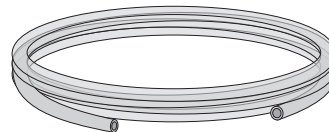

6' **TU755**
Coolant Overflow Drain Line
3/4" OD x 1/2" ID
Clear PVC

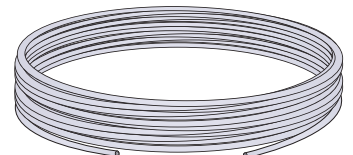

18' **TU749**
High Temperature Feed Line
1/4" OD x 0.185" ID
Teflon®

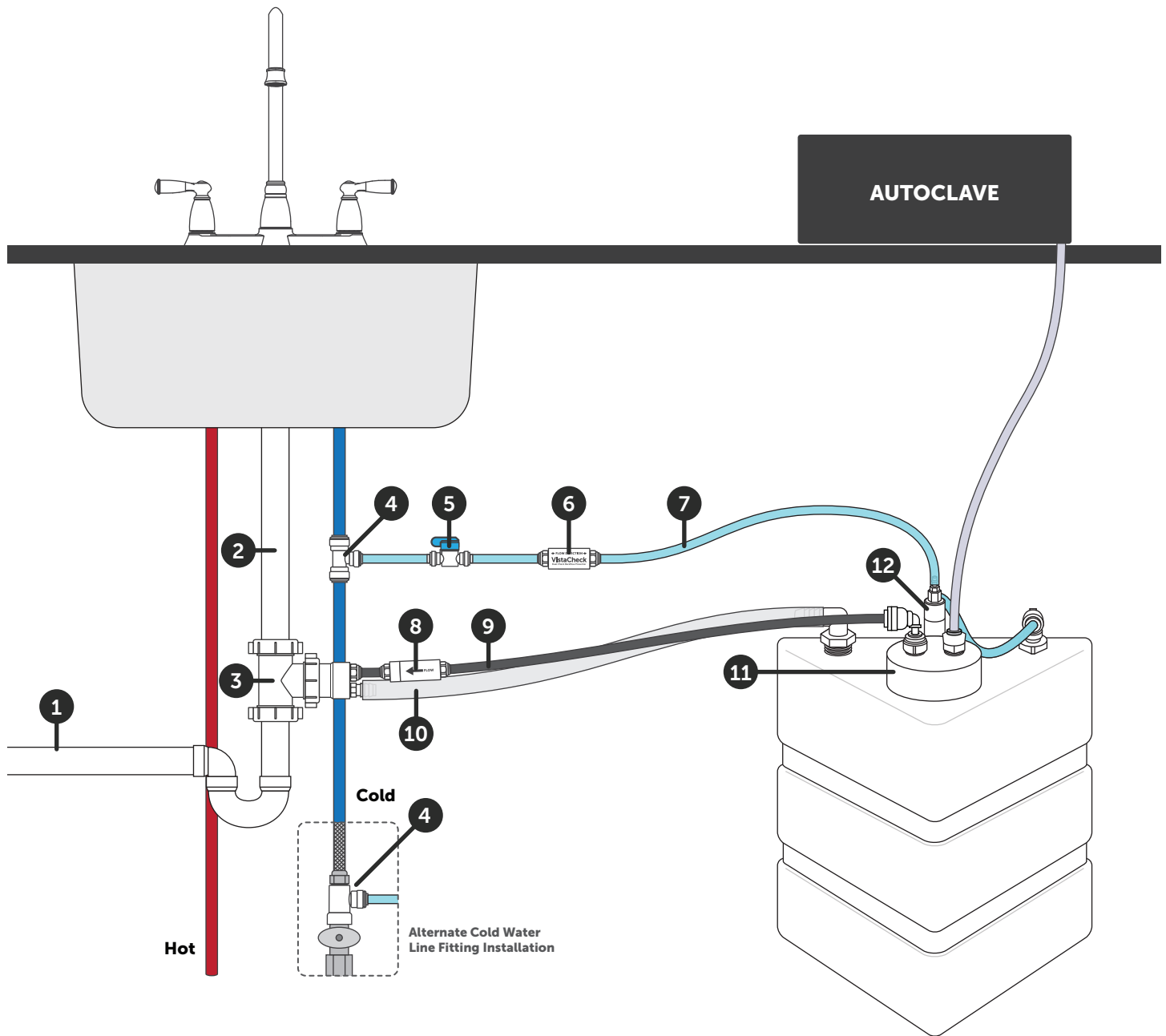

1 Drain Line

2 Sink Drain

3 **S7506**
Drain Line Assembly

4 **S6119 or S6135**
Cold Water Line Fitting

5 **S6155**
Water Supply Valve

6 **VC250-A**
VistaCheck Backflow Preventer

7 **TU751**
Cold Water Feed Line

8 **S7508**
Inline Thermal Sensor Assembly

9 **TU753**
Condensate Drain Line

10 **TU755**
Coolant Overflow Drain Line

11 Manifold Coil Assembly

12 Thermal Regulator Assembly

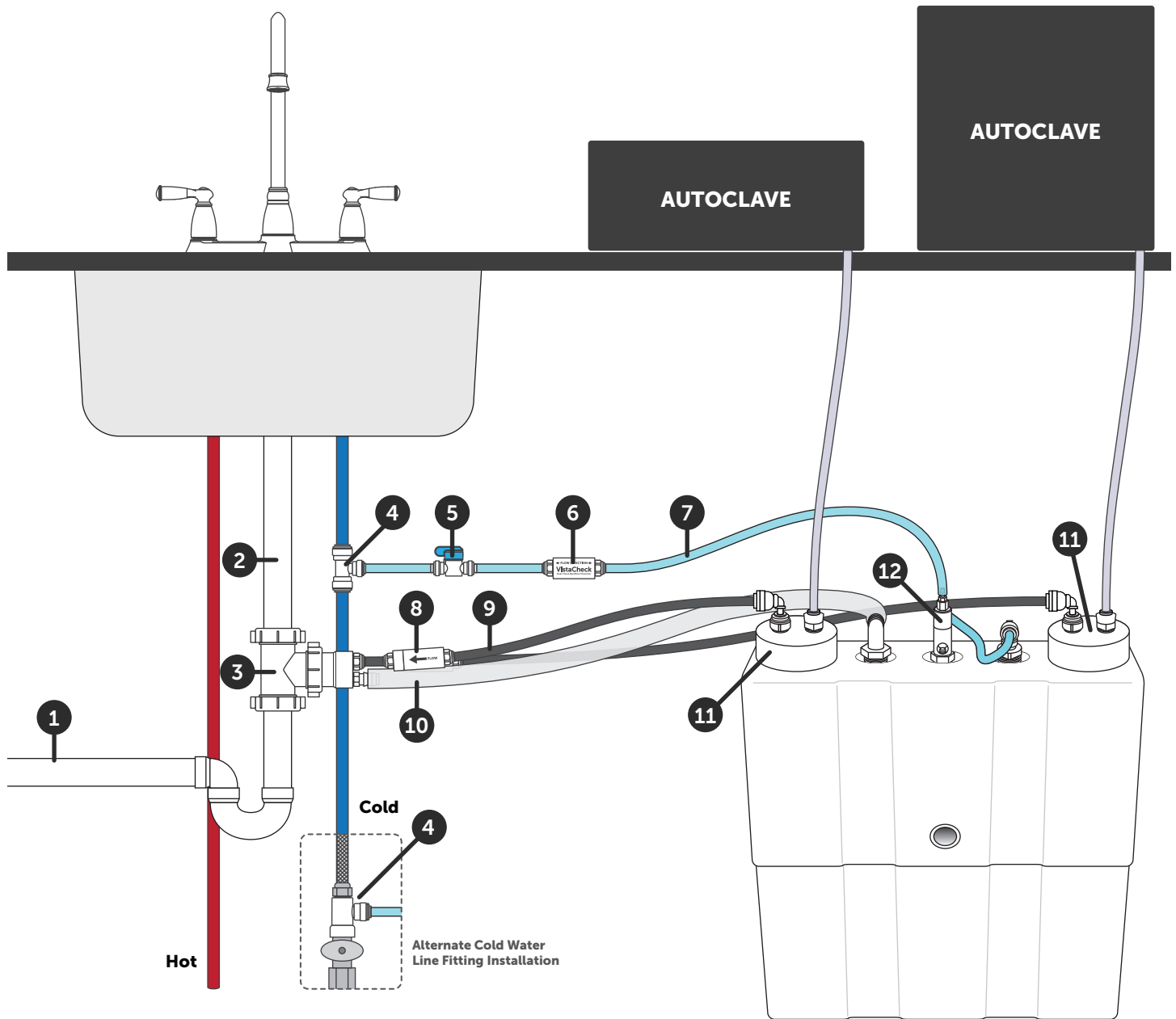

1 Drain Line

2 Sink Drain

3 **S7506**
Drain Line Assembly

4 **S6119 or S6135**
Cold Water Line Fitting

5 **S6155**
Water Supply Valve

6 **VC250-A**
VistaCheck Backflow Preventer

7 **TU751**
Cold Water Feed Line

8 **S7508**
Inline Thermal Sensor Assembly

9 **TU753**
Condensate Drain Line

10 **TU755**
Coolant Overflow Drain Line

11 Manifold Coil Assembly

12 Thermal Regulator Assembly

Plumbing

Whether installing a single or double-autoclave VistaCool unit, the cold water (coolant) supply and drain (condensate and coolant overflow) connections are exactly the same.

- 1 Turn off water supply. Provide for a 1/4" connection to the cold water supply. This is usually accomplished using a compression fitting or one of the supplied fittings (S6119 or S6135) on the cold water line.
 - 2 Cut a 3" to 4" piece of the blue poly tubing and connect the installed fitting (from step 1) to the inlet of the inline water valve provided. Be certain the valve is in the closed position (blue lever 90-degrees to the valve body).
 - 3 Cut another 3" to 4" piece of blue poly tubing and connect one end to the outlet end of the inline valve, and the other end to the inlet of the supplied CSA-certified VistaCheck dual check backflow preventer.
 - 4 Measure the drain tee adapter assembly for placement into the drain piping. Cut and remove a section (usually 1-1/2") in the appropriate place above the trap as shown. Keep the entire assembly as low as possible while maintaining a minimum of 1" offset from the barb fitting as shown. Rotate the drain adapter hub so the barb fitting is at the 6:00 position.
- Be sure to tighten slip-joint tee's nuts once all steps are complete.

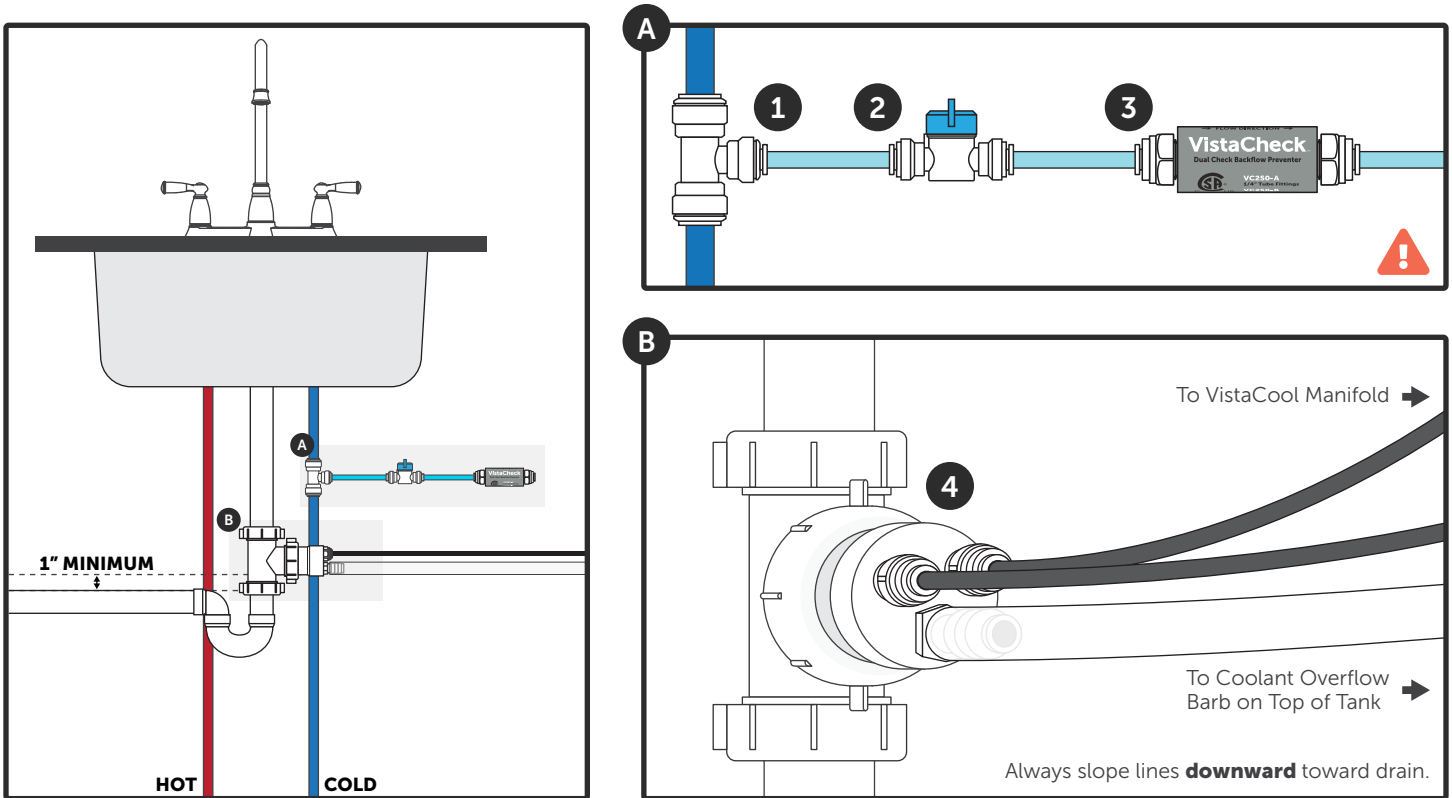

! Connect VistaCool to cold water supply ahead of foot switch (if present) for uninterrupted water supply!

NOTE:

When installing the black 1/4" OD condensate line with a 7501 system, make sure to install the white 1/4" plug in the remaining open fitting on the adapter to prevent water from flowing out of the drain. When installing a 7502 system, connect a black condensate line to each of the two 1/4" push-to-connect fittings and set the white plug aside.

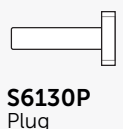

Cabinetry

VistaCool systems are typically installed in the base/sink cabinet of sterilization centers. The systems should always be installed as close to the drain system and cold water supply line as possible. The 1/4" O.D. Teflon high temperature tubing will need to run from the output port of the autoclave directly to the VistaCool system. In many cases, holes will need to be drilled through one or more partitions in order to get the tubing from the autoclave to the VistaCool.

In order to protect the tubing from kinking or damage, grommets have been included with each system. Many cabinets are constructed of composite wood and some are metal. It's especially important to use the grommets to line the edges of the drilled holes in metal cabinets to keep the tubing from being damaged. Simply drill a 7/8" pilot hole through the metal or wood partition then push the smooth plastic grommet into the holes. Make sure to drill the holes so that the tubing makes a progressively descending angle from the autoclave to the VistaCool. The hole entering the cabinet where the VistaCool is installed should be above the top of the tank manifold so the tubing has a natural gravity angle to help prevent pools of liquid in the tubing.

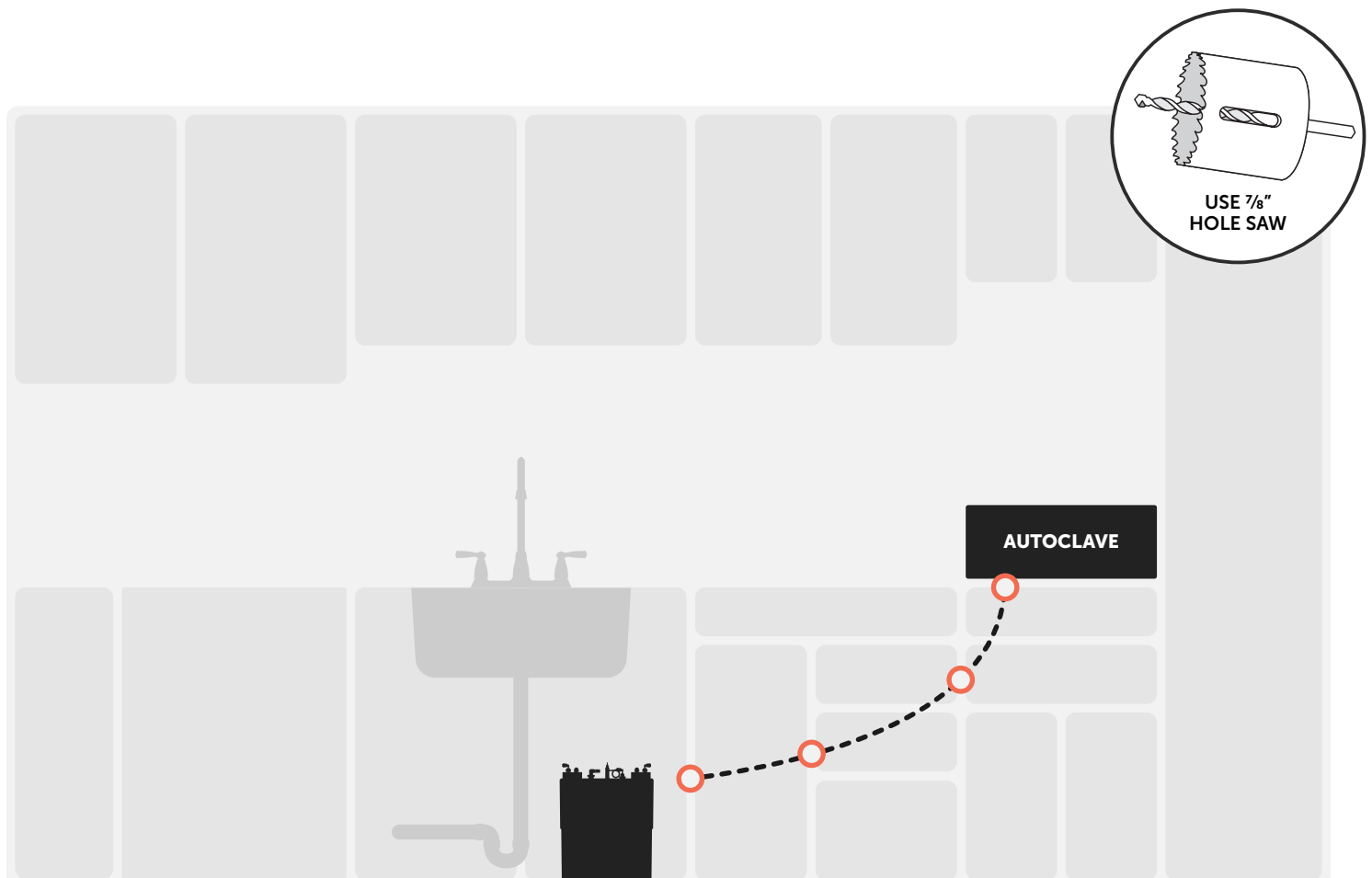

NOTE:

A 9' length of the high temperature Teflon tubing is included with each single (7501) and an 18' length is included with each double (7502) VistaCool system. An additional 18' length of Teflon tubing is available as an accessory (TU749). **Do not exceed 10' in length for any individual section of tubing between an autoclave and the VistaCool.** Always try to minimize the length of run of tubing to reduce friction and prevent "traps" and pooling in the lines.

Connecting the System

- All tubing cuts must be even and clean.
- Most fittings are a push-to-connect design. Use a twisting motion when pushing tubing into the fittings to ensure ends are fully inserted through the collet and into the internal "O" ring.
- Several fittings are a hose barb design. The $\frac{1}{8}$ " metal barbs are extremely strong and tight when the tubing is pushed on. If you must remove the tubing for any reason, make a cut along the edge of the tubing at the barb then remove, make a fresh cut and reinstall.
- The remaining barb connections are thermoplastic, and the tubing should be held in place sufficiently by being stretched over the barbs since there is no pressure in the lines. However, if you feel the tubing could be pulled during normal use, you may wish to install a stainless hose clamp to hold the tubing firmly in place.
- Do NOT use Vaseline or other lubricants (other than clean water) on the tubing. Moisten the tubing ends with water before inserting tubing into push-to-connect fittings if lubrication is needed.
- Cut the tubing to a sufficient length so that no tubing line is tight or stressed, and so the VistaCool tank assembly can be moved within the cabinet easily.
- Tubing connecting to the drain (both the condensate lines and coolant line) should be as short as possible and must not droop, loop or sag in a way that would form a trap that could cause flow restriction or backpressure.
- Ensure that fluid flow is not impeded by kinked or bent tubes.
- Manually FILL THE TANK before starting the system. See below.



- 1 Fill the water tank COMPLETELY.** Remove the manifold and coil assembly from the tank by twisting the manifold counter clockwise. Fill the tank with COLD water, replace the coil manifold into the open hole and place the tank into position under the sink.

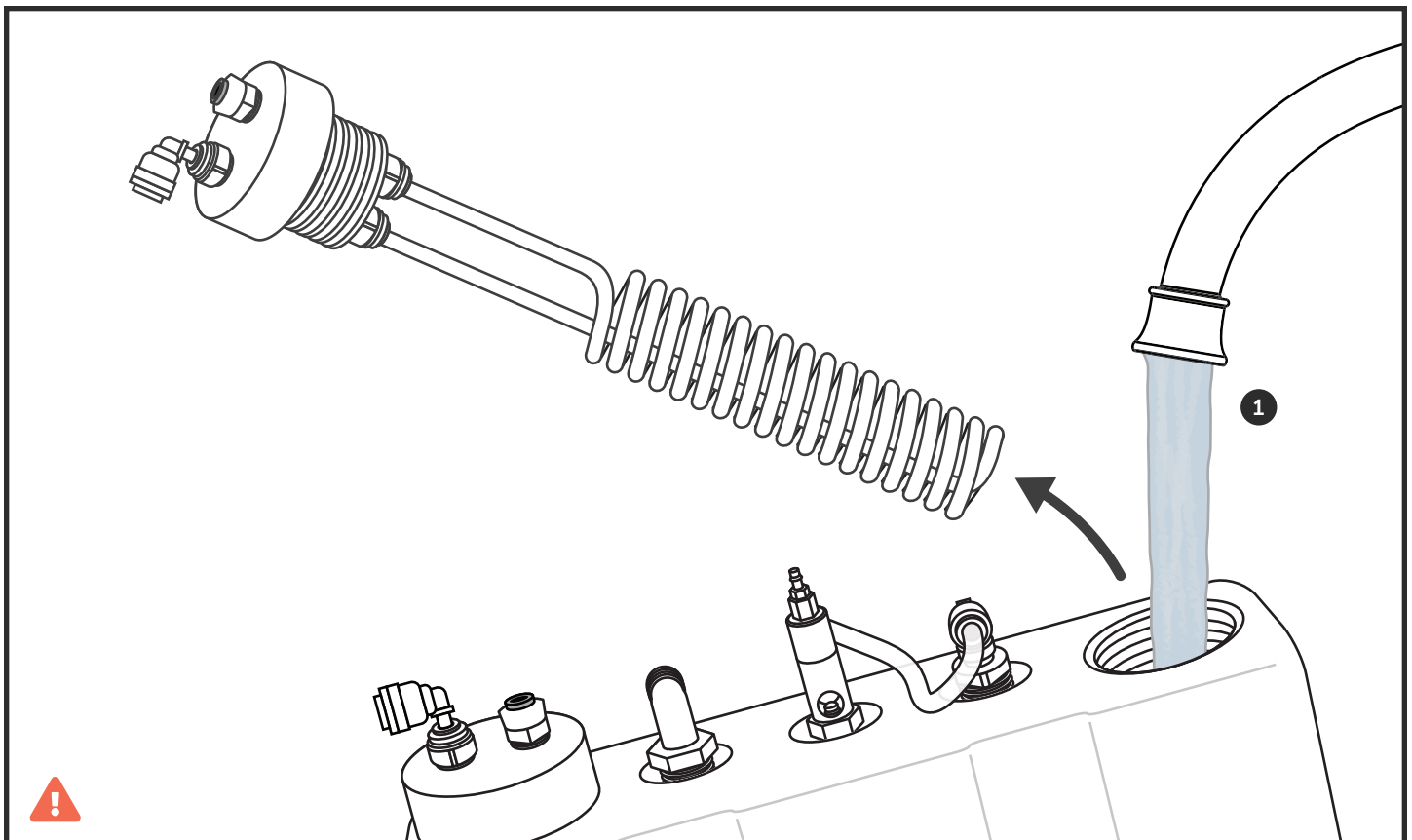

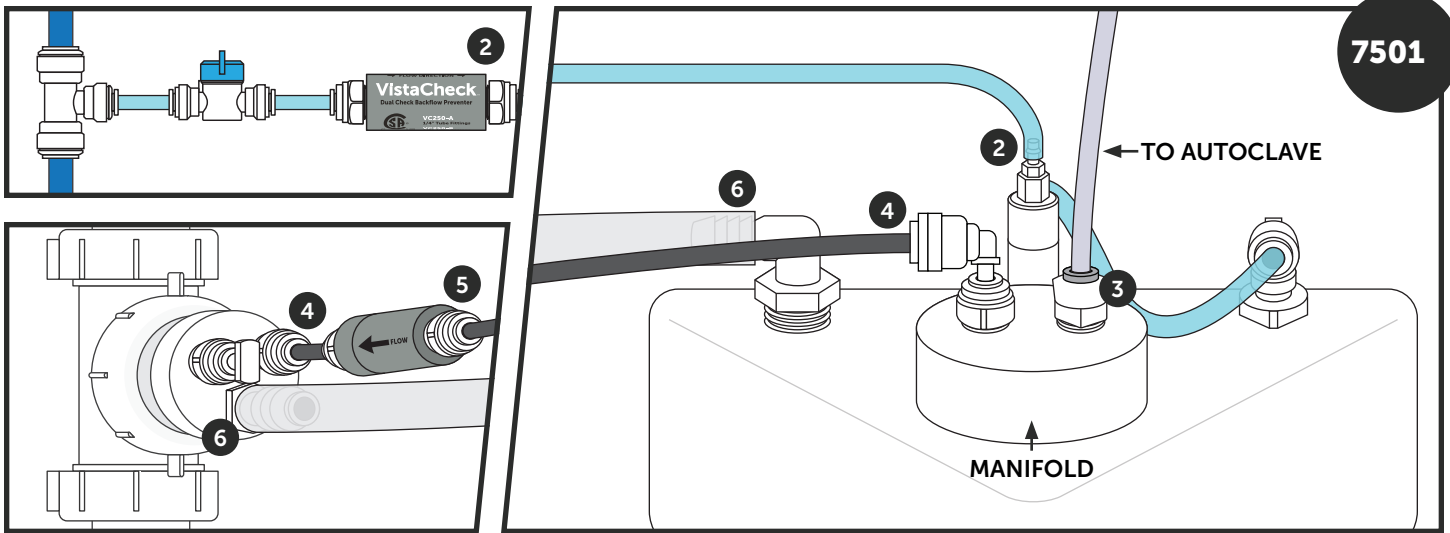

- 2 Connect the cold water supply to the water tank using the blue, semi-transparent (1/4" OD x 1/8" ID) polyurethane tubing to the system. Continue the tubing from the outlet of the VistaCheck to the top stainless hose barb on top of the brass water valve on the thermal regulator. Optional: warm the end of the tubing with hot water before pushing it over the barb and make sure it is pushed down completely over the stem of the barb and is flush with the hex stainless base of the barb.
- 3 Connect the high-temp Teflon 1/4" OD tubing from the autoclave to the milky white Kynar fitting on top of the white manifold. Make sure the tubing does not kink when moving the autoclave or pulling the tubing through the cabinet partition holes.
- 4 Connect the black 1/4" OD LLDPE condensate line tubing to the elbow fitting on the top of the manifold, then connect the other end to one of the male adapter fittings on the drain adapter.
- 5 Cut the black condensate line (from step 4) as close to the drain adapter assembly as possible and install the in-line thermal sensor. Make certain the flow direction on the in-line sensor is oriented towards the drain.
- 6 Connect one end of the 1/2" ID clear PVC tubing to the elbow hose barb on the tank and the other end to the straight 1/2" hose barb on the drain line adapter. Make sure the tubing is firmly engaged over the barbs. If in doubt, use appropriate size hose clamps.

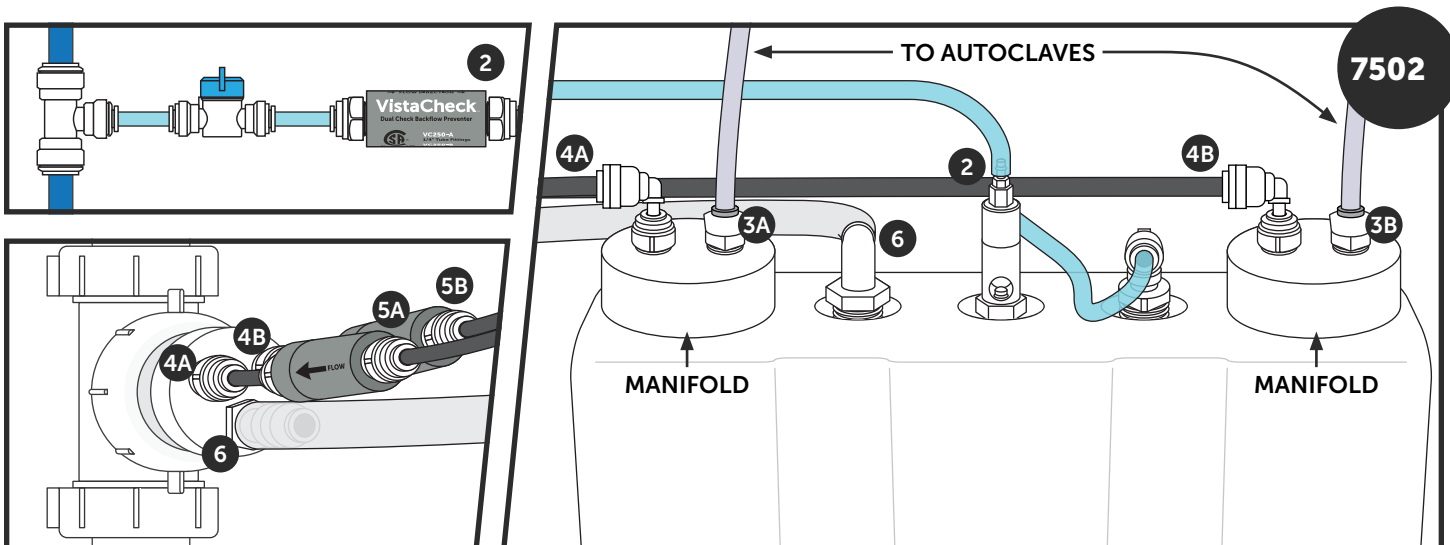

Tank Positioning

The VistaCool system should be set on a hard, level surface and installed so that the top of the water tank is **above** the coolant overflow fitting on the drain adapter assembly, and **below** the autoclave outlet. If the tank is below the level of the coolant overflow fitting, the system may not operate properly. Installing a tank at the wrong height may create resistance for proper water flow, since the system is designed to take advantage of gravity flow.

i Adjustable tank stands for installing the VistaCool at the correct height are available as accessories when needed (S7545 for use with single-unit 7501; S7547 for use with double-unit 7502). These stands raise the tank height between 1/2" and 5" in 1/2" increments.

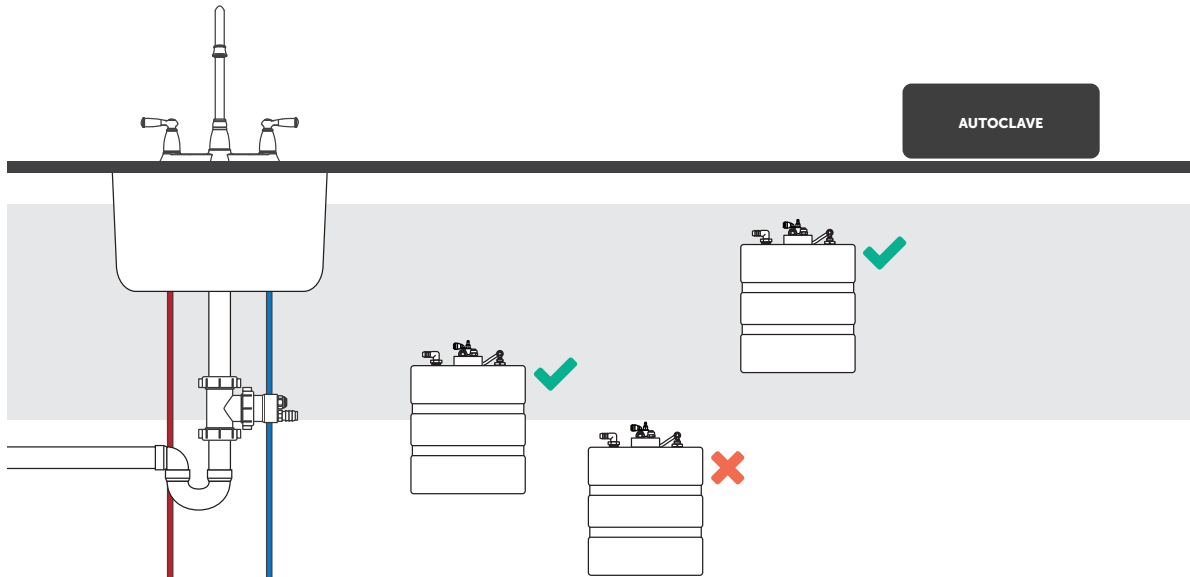

Starting & Using the System

- 1 Turn on the main water supply and check for leaks.
- 2 Slowly open the inline water supply valve fully and check for leaks.
- 3 Prime the system by inserting a small screwdriver in the view port hole on the brass stem of the thermal regulator on top of the tank and pushing **up** on the water valve piston. The system is primed when water can be seen leaving the 1/2" overflow fitting on the tank and running to the drain adapter.
- 4 Set the water tank in an elevated position above the drain connection as described above to ensure proper drain flow. The adjustable tank stand accessory (S7545 for use with single-unit 7501; S7547 for use with double-unit 7502) may be needed to securely support the tank at the proper height.
- 5 After making all connections, make sure the water coolant valve is fully open. Check again for leaks, then run three consecutive autoclave cycles to ensure everything is working properly.

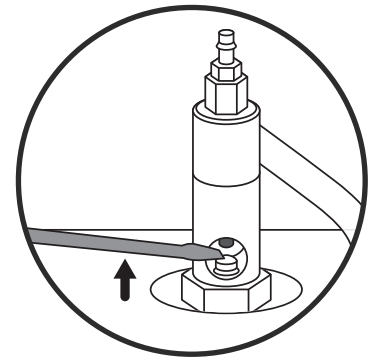

Once VistaCool is properly installed and primed it will function without operator input. Beyond periodic visual inspections of the tubing, there is nothing users must do to ensure proper operation.

Autoclave-Specific Instructions



For questions regarding the performance of an autoclave, please contact the autoclave manufacturer.

Connecting to a SciCan STATIM 2000/5000

Use of the VistaCool systems with SciCan STATIM 2000 & 5000 autoclave units requires no additional steps beyond the general instructions outlined in pages 6-12 of this guide.

Connecting to a Midmark/Ritter M3

- 1 Shut off the M3 and disconnect its power cord.
- 2 Connect the high-temperature Teflon® tubing provided to the back of the M3 as shown, and also to the high-temperature Kynar inlet on the VistaCool manifold.
- 3 Insert the 3.5mm mono plug provided with the VistaCool into the back of the M3 to override the flow display alert function.
- 4 Reconnect the M3's power cord and resume operation.

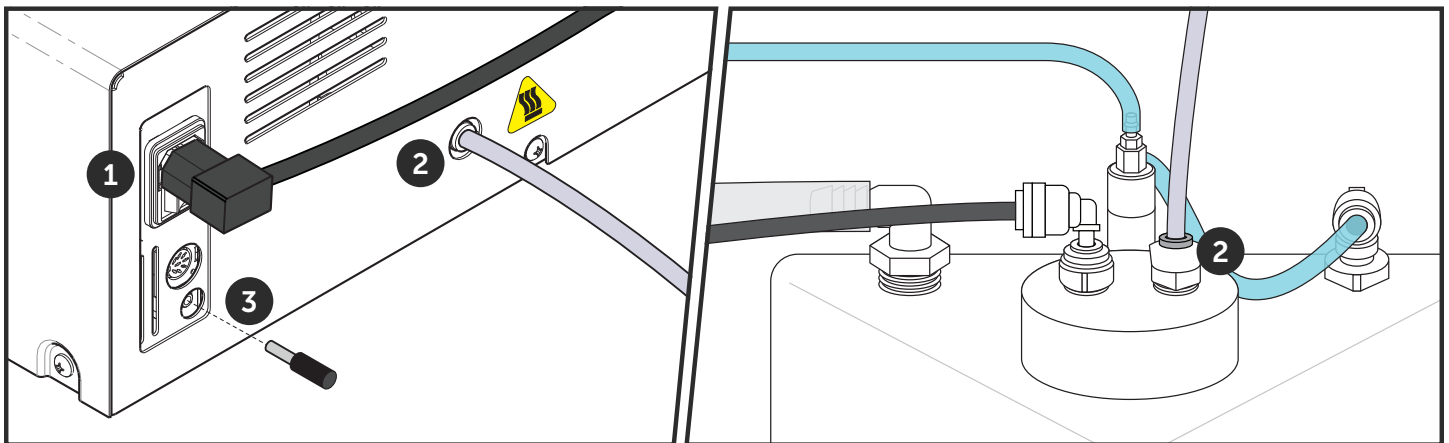

IMPORTANT INFORMATION

Midmark/Ritter M9 & M11 Compatibility

- ⚠ VistaCool Model 7502 has been verified for installation on Midmark/Ritter M9 & M11 units with the use of the S7560 adapter kit. Only M9, M9D, M11 and M11D (-02X, -03X) units with **green** displays can be connected to VistaCool. First generation models with **red** displays (-0XX) are not compatible.
- ⚠ The single-unit VistaCool (7501) should **not** be used with Midmark/Ritter M9 or M11 units. The double-unit VistaCool (7502) is capable of handling any two compatible autoclaves.

Complete installation instructions for the M9 & M11 units are included with the S7560 adapter kit.

Maintenance

The VistaCool direct-to-drain thermal reduction systems for autoclaves have been designed to require virtually no maintenance. However, it's recommended that operators periodically verify that the tubing and connections remain leak-free, are free of mineral deposits or debris, and are not compromised in any way. The system includes several fail-safe devices designed to stop the flow of exhaust water from the autoclave in the event of a problem. Here are a few recommended procedures:

OPERATOR	TECHNICIAN
<p>EVERY 6 MONTHS</p> <ul style="list-style-type: none"> • Check clear tubing for mineral deposits. • Visually inspect all connections to ensure there are no leaks. 	<p>ANNUALLY</p> <ul style="list-style-type: none"> • Visually inspect system for leaks. • Manually cycle the water valve piston. Push upward on the piston to make certain water runs to out the coolant overflow line to the drain. (See page 12 for more details)

Troubleshooting

TECHNICIAN	
<p>System is not draining</p>	<ul style="list-style-type: none"> • Ensure water supply valve is in the ON position. • Check for blockages in the tubing. • Check water level in tank.
<p>Autoclave is displaying a cycle fault</p>	<ul style="list-style-type: none"> • Exhaust port line is blocked. Check for kinks in tubing from the autoclave to the VistaCool manifold. • Check that water is running from the tank coolant overflow line to the drain adapter. • Make certain water supply valve is on. If there is no water to cool the coil(s) in the tank, the inline thermal sensor located in the condensate line will respond by closing the pathway to alert you of the problem and protect the plumbing from steam.
<p>The black condensate line appears to be blocked</p>	<ul style="list-style-type: none"> • The inline thermal sensor has been activated, blocking condensate flow to the drain, caused by a lack of coolant water in the tank that overheated the condensate. Overheated condensate will cause the wax motor to expand, closing the outlet. To reset the inline sensor and enable flow to resume, allow the system to rest and cool naturally. The inline sensor's wax-motor piston will retract, opening the outlet port.
<p>Water tank is bloated</p>	<ul style="list-style-type: none"> • Raise the water tank so the top of the tank is above the drain port as described on page 12. Ensure that the condensate drain line(s) and coolant overflow drain line all slope downward from the VistaCool system toward the drain assembly with no "dips" in the lines.
<p>Water leaking under counter</p>	<ul style="list-style-type: none"> • Check all tubing and fitting connections • Push in on all push-to-connect fittings to ensure the tubing is fully engaged in the fitting "O" ring.

VistaCool Limited Warranty

During the time period and subject to the conditions hereinafter set forth, Vista Research Group, LLC (VRG) will repair or replace to the original user any portion of a VistaCool which proves defective due to defective materials or workmanship of VRG. Contact your nearest authorized VRG distributor/ dealer for warranty service. At all times VRG shall have and possess the sole right and option to determine whether to repair or replace defective equipment, parts, or components. Damage due to conditions beyond the control of VRG is **NOT COVERED BY THIS WARRANTY**. (Contact parcel or freight company for claims on freight damaged in transit)

WARRANTY PERIOD: VRG shall warrant its VistaCool systems for a period of one (1) year from the date of installation, or eighteen (18) months from the date of manufacture, whichever comes first.

LABOR, ETC., COSTS: VRG shall *IN NO EVENT* be responsible or liable for the cost of field labor or other charges incurred by any customer in removing and/ or re-affixing any VRG product, part or component thereof.

THIS WARRANTY WILL NOT APPLY: (a) To defects or malfunctions resulting from failure to properly install, operate or maintain the unit in accordance with printed instructions provided; (b) to failures resulting from abuse, accident or negligence; (c) to normal maintenance services and the parts used in connection with such service; (d) to units which are not installed in accordance with applicable local codes, ordinances and good trade practices; (e) if the unit is moved from its original installation location, or; (f) if the unit is used for purposes other than for what it was designed and manufactured.

RETURN OF REPLACED COMPONENTS: Any item to be replaced under this Warranty must be returned to Vista Research Group, LLC (VRG) in Ashland, Ohio, or such other place as VRG may designate, freight prepaid. Write to the address listed below for a return authorization and the physical address to which items should be returned for warranty attention.

PRODUCT IMPROVEMENTS: VRG reserves the right to change or improve its products or any portions thereof without being obliged to provide such change or improvement of units sold and/or shipped prior to such change or improvement.

WARRANTY EXCLUSIONS: As to any specific VRG product, after the expiration of the time period of the warranty applicable thereto as set forth under the heading "Warranty Period" above, *THERE WILL BE NO WARRANTIES, INCLUDING ANY IMPLIED WARRANTIES OF MERCHANTABILITY OR FITNESS FOR ANY PARTICULAR PURPOSE.*

Some states do not allow limitations on how long an implied warranty lasts, so the above limitations may not apply to you. No warranties or representations at any time made by any representative of VRG shall vary or expand the provisions hereof.

LIABILITY LIMITATION: *IN NO EVENT SHALL VRG BE LIABLE OR RESPONSIBLE FOR CONSEQUENTIAL, INCIDENTAL OR SPECIAL DAMAGES RESULTING FROM OR RELATED IN ANY MANNER TO ANY VRG PRODUCT OR PARTS THEREOF.*

Some states do not allow the exclusion of limitation of incidental or consequential damages, so the above limitation or exclusion may not apply to you.

This Warranty gives you specific legal rights and you may also have other rights which vary from state to state.

For your warranty protection (Magnason-Moss Warranty Act), the warranty card, if provided, should be completed and returned to VRG within ten (10) days of installation. Alternatively, register your product online within ten (10) days of installation at **vrg.support/register**. In the absence or other suitable proof of installation date, the effective date of this warranty will be based upon the date of manufacture plus one hundred eighty (180) days.

Vista Research Group

 VistaResearchGroup.com  vrg.support  (419) 281-3927
 1733 West Parkside Lane, Phoenix, AZ 85027

VistaCool System Information

Thank you for choosing the VistaCool Direct-to-Drain Thermal Reduction System for Autoclave Wastewater for your practice! The following chart is for necessary information for future reference. Please fill it out completely and keep this manual in a convenient place for ready access and reference.

Be sure to use our convenient online warranty registration form at vrg.support/register. If you'd prefer, you may complete and return the included "Warranty Registration" sheet. Make a copy of the form for your records, then mail the original to us.

VistaCool Direct-to-Drain Thermal Reduction Systems for Autoclave Wastewater		System Model #	
Install Date		System Serial #	
Dealer		Installer Name	
Dealer Phone		Installer Phone	
Dealer Address		Notes	

	7501	7502
Tank Material	Polyethylene - Natural White	
Tank Dimensions (with fittings)	7.6" W x 7.6" L x 13.75" H 19.3 cm x 19.3 cm x 34.9 cm	4.0" W x 13.0" L x 17.0" H 10.2 cm x 33.1 cm x 43.2 cm
Tank Volume	1.50 Gallons / 5.70 Liters	3.00 Gallons / 11.40 Liters
Tank Weight (w/ water & Fittings)	15.0 lbs. / 6.8 kg	28.0 lbs. / 12.7 kg
Approximate Shipping Weight	7.0 lbs. / 3.2 kg	10.0 lbs. / 4.5 kg
Coolant Water Connection	Supply fitting for ¼" O.D. required. To be provided by installer.	
Max Coolant Water Pressure	100 psi / 6.9 bar	
Max Altitude (If using Air Gap)	6,561 feet / 2000 meters	

